



Phocos CIS

Bedienungsanleitung

User Manual

Manual de Instrucciones

Guide de l'utilisateur

Manual do Usuário

用户说明书



CID: 181814611

CONTENTS

Bedienungsanleitung	1-10
User Manual	11-30
Manual de Instrucciones	31-40
Guide de l'utilisateur	41-50
Manual do Usuário	51-60
用户说明书	61-70

Bitte lesen Sie die Anweisungen sorgfältig und gründlich durch, bevor Sie das Produkt in Betrieb nehmen. Es ist ausgestattet mit einer Reihe von herausragenden Eigenschaften, wie z. B.:

- Schutzklasse: IP68 -72 Stunden in einer Wassertiefe von 1,50 m.
- Doppel- Last.
- Kontroll-Einheit (CU) zur Konfiguration des CIS Laderegler mittels Infrarot-Datenverbindung.
- Externer Temperaturfühler für die Temperaturkompensation der Ladespannungen.
- umfassende Programmierbarkeit.
- 3-stufiges Ladeverfahren (Boost-Ladung, Ausgleich, Erhaltung) für Flüssigsäure-Akkus, 2-stufige Aufladung (Hauptladung, Erhaltungsladung) für verschlossene Batterien.
- Automatische Erkennung der Systemspannung 12/24 V.

Anschluss und Erdung



- Um Störungen zu vermeiden schließen Sie die Kabel in der Reihenfolge 1234567, wie in der Installationsanleitung beschrieben an.
- Zur Vermeidung jeglicher Spannung an den Kabeln, zuerst das Kabel mit dem Laderegler verbinden, dann die Batterie oder die Verbraucher anschließen.
- Empfohlene minimale Kabelquerschnitte: CIS05: 1,5 mm², CIS10: 2.5 mm², CIS20: 4 mm².
- Stellen Sie sicher, dass die Kabellänge zwischen Batterie und Laderegler möglichst kurz gewählt ist.
- Vergewissern Sie sich, dass sämtliche Pluspole des CIS-Laderegler zusammengefasst angeschlossen und auf einen elektrische Potential verschaltet wurden. Wenn eine Erdung erforderlich ist, ist dies immer mit dem positiven Kabel zu bewerkstelligen.

- Elektronische Verbraucher, wie Relais, Steuereingänge oder Motoren, können den Laderegler durch magnetische Induktion beim Ausschalten beschädigen. Um dies zu verhindern, schließen Sie die Diode (wie 1N5401...1N5408) in Sperrrichtung zwischen Positiver Lastanschluss und Negativer Lastanschluss.

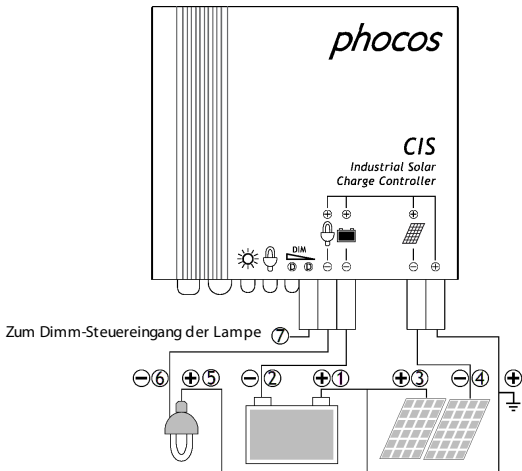
	Funktion	Kabelkennzeichnung	Kabelquerschnitt	Farbe
①	Positiver Batterieanschluss	COMMON +	2.5 mm ²	rot
②	Negativer Batterieanschluss	BATTERY -	2.5 mm ²	schwarz
③	Positiver Panelanschluss	COMMON +	2.5 mm ²	rot
④	Negativer Panelanschluss	SOLAR -	2.5 mm ²	blau
⑤	Positiver Lastanschluss	COMMON +	2.5 mm ²	rot
⑥	Negativer Lastanschluss	LOAD -	2.5 mm ²	grün
⑦	Dimm-Signal Anschluss	---	0.6 mm ²	schwarz



Anzeige & Warnfunktionen

LED	Staus	Funktion
	Ein	Laderegler an den Akkumulator angeschlossen, Nachterkennung
	Blinken	Laderegler an die Akkumulator angeschlossen, Tag erkannt
	Aus	kein Akkumulator angeschlossen
	Ein	Last Tiefentladeschutz-/Überspannungs-Lastabwurf (LVD / HCD)
	Blinken	Last Überstrom
	Aus	Last ok
	On	dimmen aufgrund (LVD / HVD)
	Off	zeitgesteuertes Dimmen
Alle LED	grün, rot, grün	Programmierung

Nachtlicht-Funktion

Dieser CIS-Laderegler ist mit einer hochentwickelten Nacht-Licht-Funktion ausgestattet. Er steuert den Lastausgang nachts und ist umfassend programmierbar. Beide Ausgänge sind frei programmierbar.

Es stehen 3 Modalitäten zur Verfügung:

Standard-Controller, Abenddämmerung-bis-Morgendämmerung und Abend/Morgen-Modi.

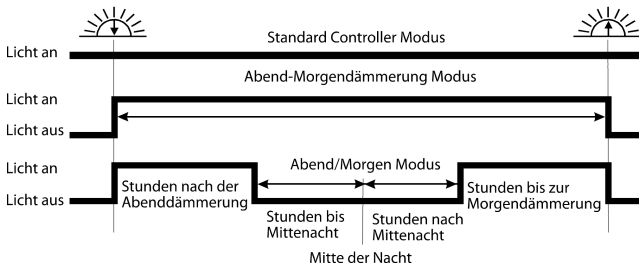

“Mitter der Nacht” wird automatisch als Mittelpunkt zwischen Dämmerung und den Morgenstunden betrachtet, dadurch ist keine Zeiteinstellung erforderlich. Es kann mehrere Tage dauern, bis der Laderegler die Mitternacht exakt "registriert" hat. "Mitte der Nacht" kann je nach Standort von 12:00 Uhr abweichen.

Der Laderegler erkennt Tag und Nacht aufgrund der Leerlaufspannung des Solargenerators. Diese Tag / Nacht-Schwelle kann an die örtlichen Lichtverhältnisse und den Solargenerator angepasst werden.

Sicherheits-Merkmale

	Solar-Anschluß	Batterie-Anschluß	Lastanschluss
Verpolungsschutz	Geschützt (1)	Geschützt (1)	Geschützt (2)
Kurzschluss	Geschützt	Geschützt (3)	Schaltet sofort ab
Überstrom	N / A	N/A	Schaltet ab mit Verzögerung
Rückstrom	Geschützt	N/A	N/A
Überspannung	Max. 55 V (4)	Max. 40 V	Schaltet ab über 15,5 V / 31,0 V
Unterspannung	N/A	N/A	Schaltet ab
Übertemperatur	Reduziert den Ladestrom via PWM, wenn Übertemperatur auftritt und schaltet die Last ab, wenn die Temperatur ein hohes Niveau erreicht hat.		

(1) Der Laderegler besitzt kein Eigenschutz für ein 24 V-System; Modul-Batteriespannung ist begrenzt auf 40 V.

(2) Der Laderegler kann sich selbst schützen aber Verbraucher können zerstört werden.

(3) Die Batterie muss durch eine Sicherung geschützt werden, ansonsten kann die Batterie dauerhaft geschädigt werden.

(4) Die Solarmodul-Spannung sollte diese Grenze nicht über einen längeren Zeitraum hinweg überschreiten. Ein Überspannungsschutz wird durch einen Varistor realisiert.

WARNUNG: Die Kombination verschiedener Fehler kann zu Schäden am Laderegler führen. Beheben Sie stets zuvor den Fehler, bevor Sie den Laderegler wieder in Betrieb nehmen.

Testfunktion

Das Drücken der Test-Taste auf der CU (Kontroll-Einheit) bewirkt, dass beide Lastklemmen für 2 Minuten eingeschaltet werden.

Wenn beim drücken der Taste ein Lastabwurf ausgelöst wird (LVD / SOC, Überstrom) wird die Last abgeschaltet.

Tiefentladeschutzfunktion (LCD)

- Ladezustandsgesteuert (SOC): Abschalten bei
11,00 V/22,00 V bis 11,70 V/23,40 V (SOC1), 11,12 V/22,24 V bis 11,76 V/23,52 V (SOC2),
11,25 V/22,50 V bis 11,83 V/23,63 V (SOC3), 11,38 V/22,72 V bis 11,89 V /23,78 V (SOC4),
11,51 V/23,02 V bis 11,96 V/23,92 V (SOC5), 11,64 V/23,28 V bis 12,02 V/24,04 V (SOC6).
- Spannungsgesteuert (LVD): Abschalten bei einer festen Spannung zwischen 11,0 V/22,0 V
und 11,9 V/23,8 V (Schrittweise 0,1 V).

Hinweis: Die beiden Spannungen vor und nach dem Schrägstrich, gelten jeweils für 12 V und 24 V-Systeme.

Werkseinstellungen

Sie können den CIS Laderegler über die Kontrolleinheit (CU) konfigurieren. Siehe hierzu CU Handbuch.

	Werkseinstellung
Last-Modus	Standard Laderegler
Tiefentladeschutz	SOC4
Batterietyp	Verschlossen
Dimmwert	50 %

Haftungsausschluss

Der Hersteller haftet nicht für Schäden, insbesondere an der Batterie, die durch eine nicht wie vorgesehene oder wie im Handbuch beschriebene Verwendung entstehen, oder wenn die Empfehlungen Batterieherstellers missachtet werden.

Der Hersteller haftet nicht, wenn Reparaturen oder Services von nicht autorisierten Personen durchgeführt wurden. Ebenso bei unsachgemäßem Gebrauch, falscher Installation oder falscher Systemauslegung.

Technische Daten

Systemnennspannung	12/24 V, automatische Spannungserkennung
Boost-SpannungSpannungshauptladung	14.4/28.8 V (25 ° C), 2 h
Ausgleichsspannung	14.8/29.6 V (25 ° C), 2 h
Erhaltungsspannung	13.8/27.6 V (25 ° C)
Lastabwurfspannung	11,00-12,02 V/22.00-24.04 V durch SOC 11,0-12,0 V/22.0-24.0 V durch Spannung
Lastzuschaltspannung	12.8/25.6 V
Abendstunden/Vormittagsstunden	0-15 Stunden/0-14 Stunden
Dimmwert	0... 100 %
Dimm-Ausgangsspannung	0 V bis 10 V relativ zu Batterie-Minus
Tag / Nachterkennung	2.5-10 V
Akkumulator-Typ	Flüssigsäure, verschlossen
Temp.-Kompensation	-4,2 mV / K pro Zelle
Max. Solarstrom	5/10/20, je nach Modell-Nummer @ 60 ° C
Max. Laststrom	5/10/20, je nach Modell-Nummer @ 60 ° C
Abmessungen	82 x 58 x 20 mm

Kabelquerschnitt	AWG 13 (2.5 mm ²)
Typische Leistungsaufnahme	Kleiner 8/10 mA
Umgebungstemperatur-Bereich*	-40 Bis +60 ° C
Geräteschutzklasse	IP68 (1,5 m, 72 h)
Maximale Höhe über N.N./Gewicht	4000 m / 150 g

*: Ab 60 ° C, kann der CIS-Laderegler entweder den max. Solarmodul- oder den max. Laststrom verarbeiten, jedoch nicht beide Ströme gleichzeitig.

Änderungen jeder Art vorbehalten, selbige können ohne vorherige Benachrichtigung am CIS-Lageregler vorgenommen werden.

Version: 20130412

Hergestellt in einem der folgenden Länder:
 Deutschland - China - Bolivien - Indien
 Phocos AG - Deutschland www.phocos.com

ISO9001



Please read the instructions carefully and thoroughly before using the product. It comes with a number of outstanding features, such as:

- Case protection: IP68 protection, in 1.5 m water depth 72 Hours.
- Dimming function
- Control unit (CU) to configure CIS charge controller via infra-red data link
- External temperature sensor for temperature compensation of charge voltages
- Widely programmable
- 3 stage charging (boost, equalization, float) for flooded battery, 2 stage charging (boost, float) for sealed battery
- Automatic recognition of system voltage 12/24 V
- Positive grounding

IMPORTANT SAFETY INSTRUCTIONS



SAVE THESE INSTRUCTIONS

This manual contains important instructions for CIS-05-1.1, CIS-10-1.1, CIS-20-1.1, CIS-05-1.1-2L, CIS-10-1.1-2L, CIS-20-1.1-2L models that shall be followed during installation and maintenance of the charge controller.

INSTRUCTIONS DE SÉCURITÉS IMPORTANTES

CONSERVER CES INSTRUCTIONS

Cette notice contient d'importantes instructions visant les modèles CIS-05-1.1, CIS-10-1.1, CIS-20-1.1, CIS-05-1.1-2L, CIS-10-1.1-2L, CIS-20-1.1-2L, lesquelles doivent être suivies au moment de

l'entretien de l'appareil.

If connection to the power lead or battery lead are accessible during operational maintenance the following warning shall be marked adjacent to the connection where practical or prominently displayed on the enclosure: **WARNING - EXPLOSION HAZARD - DO NOT DISCONNECT WHILE CIRCUIT IS LIVE UNLESS AREA IS KNOWN TO BE NON-HAZARDOUS.** and **AVERTISSEMENT - RISQUE D'EXPLOSION. NE PAS DÉBRANCHER TANT QUE LE CIRCUIT EST SOUS TENSION, À MOINS QU'IL NE S'AGISSE D'UN EMPLACEMENT NON DANGEREUX.**

EXPLOSION HAZARD. DO NO DISCONNECT WHILE THE CIRCUIT IS LIVE OR UNLESS THE AREA IS KNOWN TO BE FREE OF IGNITIBLE CONCENTRATIONS.

THIS EQUIPMENT IS SUITABLE FOR USE IN CLASS I, DIVISION 2, GROUPS A-D, T4A.



UL 1741 and



UL 1604, ANSI/ISA 12.12.01-2011, C22.2 No. 213-M1987.

RISK OF FIRE – MOUNT IN CONTACT WITH BATTERIES

Battery type: Lead acid, (GEL, AGM, flooded)

Nominal voltage rating of the battery: 12 or 24 V

Batteries fuse: use a fast acting fuse with a minimum of 1000A interrupting rating on the battery side. We recommend to use fast acting melting fuses (e.g. car type fuses) on the battery side, as close as possible at the battery terminal with 1.5 times the current rating of the maximum nominal current (see table).

Fuse ratings:

CIS type	CIS-05	CIS-10	CIS-20
Fuse	7.5 A	15 A	30 A

Please do not disassemble or attempt to repair Phocos products. Phocos charge controllers do not contain user serviceable parts.

Please observe all instructions with regards to external fuses/breakers as indicated.

Maintenance and installation notes

When installing or working on the PV system, please disconnect the PV (solar) modules from the charge controller first, to prevent any damages to the charge controller!

Please verify that all cable/wire connections are tightly fastened to the connectors/connecting posts in order to avoid any bad or loose connections that could result in excessive heating.

Please install a fuse or breaker near the battery before installing or adjusting the controller!

Please install and operate the controller in a dry environment.

High voltage risks

Operation of this device may produce a high voltage which could cause severe injuries or death in case of improper installation or operation of the device.

PV modules can generate high DC voltages!

Make sure the cables are always connected to the correct terminal. An electrical shock can be lethal. In general, any electric shock can be dangerous to your health.

CE labeling

The product is CE compliant.

Mounting of the unit

Since the charge controller must be able to sense the battery temperature it must be mounted into the same compartment together with the battery. It shall be mounted as close as possible to battery. We recommend not to use more than 1m wire length between battery and charge controller. This apparatus is suitable for use in Class I, Division 2 groups A, B, C, D or unclassified locations.

- Vertical mounting on non flammable surface with minimum 2 cm distance below and above unit.
- In case of higher ambient temperatures and limited heat dissipation (e.g. by surrounding compartment or smaller mounting distances), charge controller will limit its charge current to reduce temperature.
- If heat dissipation is limited by surrounding compartment, unit will limit charge current to reduce temperature.
- The charge controller is not intended to be installed within the wiring compartment of a PV module. The wiring methods in accordance with the National Electrical Code, ANSI/NFPA 70 are to be used.

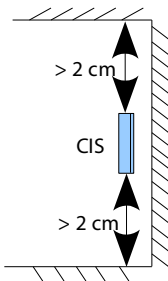

Connecting and Grounding

- Connect wires in order indicated 1 2 3 4 5 6 7 to avoid installation faults
- To avoid any voltage on the wires, first connect the wire to the controller, then to the battery, panel or load.
- Recommended minimum wire size: CIS-05: 1.5 mm²; CIS-10: 2.5 mm²; CIS-20: 4 mm²
- Make sure the wire length between battery and controller is as short as possible.
- Be aware that the Positive terminal of CIS are connected together and therefore have the same electrical potential. If any grounding is required, always do this on the Positive wires.

- Some equipment, like relays, gates or motors, can damage the controller by magnetic induction, when it switches off. To prevent this, reverse connect the diode (such as 1N5401 .. 1N5408) between LOAD positive and LOAD negative.
- Connectors used in incandive circuits and incorporated within equipment shall be considered normally non-arcing if disconnection is not required under operational maintenance conditions, and if they are so secured that a separating force of at least 15 N is required for loosening.

	Function	Cable marker	Wire size (cross section)	color
①	Positive battery terminal	COMMON +	AWG 13 (2.5 mm ²)	Red
②	Negative battery terminal	BATTERY -	AWG 13 (2.5 mm ²)	Black
③	Positive panel terminal	COMMON +	AWG 13 (2.5 mm ²)	Red
④	Negative panel terminal	SOLAR -	AWG 13 (2.5 mm ²)	Blue
⑤	Positive load terminal	COMMON +	AWG 13 (2.5 mm ²)	Red
⑥	Negative load terminal	LOAD -	AWG 13 (2.5 mm ²)	Green
⑦	Dimming signal terminal	---	AWG 19 (0.6 mm ²)	Black

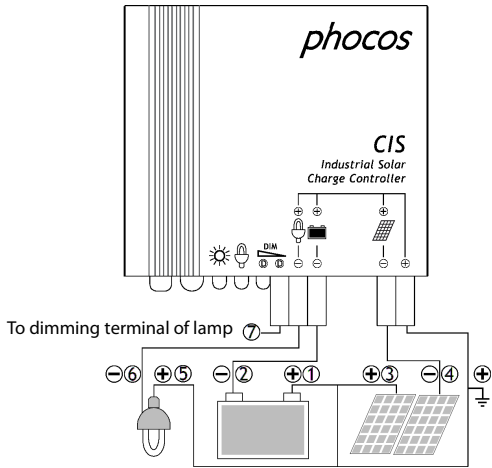

CIS operational description

EN

The CIS charge controllers are built to be operated with 12V or 24V vented and sealed lead acid batteries. A series PWM-charge controller like the CIS connects the PV-panel to the battery, to charge it or disconnects it when the battery voltage is high enough. Depending on the battery voltage it will frequently switch ON and OFF the charge current to regulate the battery voltage. This voltage depends on the charge state (Main charge/ Boost/ Equalisation/ Float)

The CIS will disconnect the PV-panel from battery at night to prevent any current to flow back from the battery to the panel at night. These functions are achieved by the use of modern semiconductor switches, called power-MOS-FETs. one is used to switch on/off the charge current, the other one acts as actively switched diode to prevent back current from flowing from the battery backwards to the PV-panel at night. The CIS also provide one or two (-2L) power outputs to supply electronic loads with electricity. The output voltage of these load outputs is the battery voltage.

To protect the battery from getting deep discharged, the charge controller will disconnect the load output at a low SOC (state of charge). This level is adjustable. To protect connected load, the CIS will also disconnect the load at too high battery voltage levels. This function is also realized by a power-MOS-FET, one for each load output. To achieve temperature compensation of the charge voltage, the CIS have got an external temperature sensor to sense the ambient (battery) temperature. The charge controller will adapt the charge voltage according to this external temperature, to provide a charge voltage compensation of -4mV per degree Celsius and battery cell (24mV/K for a 12V battery, 48mV/K for a 24V battery).



To provide over-temperature protection functions, it has also a built in temperature sensor. If the internal temperature gets higher than about 75°C (e.g. at high charge currents and high ambient temperatures, the charge current will be decreased, to limit the internal power loss and thus to reduce internal heating. If the internal temperature is too high, it will also switch off the load current. This shall prevent the charge controller from being damaged by too high internal temperatures.

CIS units with one load output have got an additional DIM-output that provides a signal between 0 .. 10V to control the brightness of a lamp by use of a compatible LED driver. Widely adjustable settings can control the load output(s) and DIM output to provide various night light functions. These can be programmed/adjusted by use of the CU, an infrared remote control especially designed for the CIS series.

This all is realized by the use of a micro-controller inside the CIS. This micro controller is a small computer, equipped with software (firmware) and integrated peripherals to measure voltages, currents and digital signals, and output digital signal, to switch on and off transistors, controlling the FETs, LEDs, etc.

Display & Warning Functions

EN

LED	Status	Function
	On	Controller connected to battery, night detected
	Flash	Controller connected to battery, day detected
	Off	No battery connected
	On	Load 1 low/high voltage disconnect(LVD/HVD)
	Flash	Load 1 over current
	Off	Load 1 OK
DIM 	On	Dimming because of low/high voltage disconnect
	Off	Time control dimming
All LED	Green->Red->Green->	Programming

Night-Light Function

The CIS controller comes with a sophisticated night-light function. It controls the load output at night and is widely programmable.

There are 3 modes available:

Standard Controller, Dusk to Dawn and Evening/Morning modes.

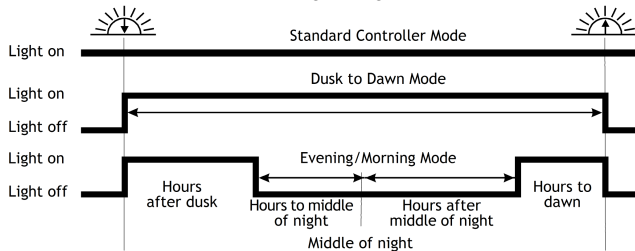

"Middle of night" is detected automatically as the midpoint between dusk and dawn, no setting of a clock is required. It may take several days until the controller has "learned" the middle of the night precisely. "Middle of night" may be different from 12:00 midnight depending on your location.

The controller recognizes day and night based on the solar array open circuit voltage.

This day/night threshold can be modified according to local light conditions and the solar array used.

EN

Dimming Function

- Output voltage 0 V to 10 V relative to battery minus(adjust step 1 V).
- Load hours(load 1 on CU case printing) and Dimming hours(load 2 on CU case printing) work together to effect dimming function:

	No dimming	Dimming on	Load off
Load hours	on	on	off
Dimming hours	on	off	N/A
Dimming output voltage	10 V	Voltage proportional to dimming level	0 V

- Corresponding relationship of 'Output voltage' and 'Dimming value'

Output voltage	0 V	1 V	2 V	3 V	4 V	5 V	6 V	7 V	8 V	9 V	10 V
Dimming value	0%	10%	20%	30%	40%	50%	60%	70%	80%	90%	100%

Testing Function

Pushing the test button on the CU (Control Unit) will switch on load terminal for 1 minute. If pressing the button causes a load disconnect event (LVD/SOC, over current) the load will be switched off immediately.

Safety Features

	PV terminal	Battery terminal	Load terminal
Reverse polarity	Protected (1)	Protected (1)	Protected (2)
Short circuit(3)	Protected (8)	Protected (4)	Switches off immediately(8)
Over current	N/A	N/A	Switches off with delay(5)
Reverse current	Protected(6)	N/A	N/A
Over voltage	Max. 55 V (7)	Max. 40 V	Switches off above 15.5/31.0 V
Under voltage	N/A	N/A	Switches off
Over temp.	Reduces the charging current by PWM if over temperature occurs and switches off the load if the temperature reaches a high level.		

- (1) Upanel-Ubattery is limited to 60 V.
- (2) Controller can protect itself, but loads might be damaged.
- (3) Short circuit: >3x – 20x nominal current.
- (4) Battery must be protected by a fuse, or the it can be permanently damaged in case of a

short circuit.

- (5) >200% nominal current: disconnect with 3s delay,
>150% nominal current: disconnect with 10s delay,
>110% nominal current: disconnect with 120s delay.
- (6) Reverse current through solar panel is blocked by serial MOSFET. This function is tested and activated approx. once in 1min +/-5s.
- (7) The solar panel voltage should not exceed this limit for a long time as voltage protection is done by a varistor.
- (8) Limited electronic protection; must be additionally protected by an external fast acting fuse against short circuit to prevent damage from charge controller; nominal fuse rating shall be 1.5 times the maximum charge current.

WARNING: The combination of different error conditions may cause damage to the controller. Always remove the error before you continue connecting the controller!

Low Voltage Disconnect Function (LVD)

- State of charge (SOC) controlled: Disconnect at
11.00/22.00 V to 11.70/23.40 V(SOC1), 11.12/22.24 V to 11.76/23.52 V(SOC2),
11.25/22.50 V to 11.83/23.63 V(SOC3), 11.38/22.72 V to 11.89/23.78 V(SOC4),
11.51/23.02 V to 11.96/23.92 V(SOC5), 11.64/23.28 V to 12.02/24.04 V(SOC6).
- Voltage controlled (LVD): Disconnect at a fixed voltage between 11.0/22.0 V and 11.9/23.8 V (Step 0.1/0.2 V).

Note: Battery voltage must be below setting for longer than 2 minutes for LVD to take effect.

Note: The two voltage levels before/after the slash are valid for 12 V and 24 V systems respectively (valid for the charge controllers in this manual).

Factory Settings

You can configure CIS charge controllers via the Control Unit (CU). See CU manual for details.

	Factory setting
Load mode	Standard controller(night light off)
Low voltage disconnect	SOC4
Battery type	Gel
Night light level	8.0/16.0 V (1)
Load 1 evening hours	0 h
Load 1 morning hours	0 h
Dimming evening hours	0 h
Dimming morning hours	0 h
Dimming value	50 %

(1) PV panel open circuit voltage: Day level = Night level + 1.5/3.0 V

Night light level

EN

The controller recognizes "day" and "night" based on the solar PV array open circuit voltage. The daylight threshold can be modified according to the requirements of the local conditions and the solar PV array used.

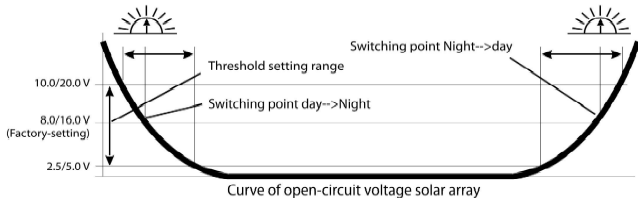

To find the correct values, we recommend measuring the PV solar array open circuit voltage at the time when twilight has reached the level when the controller should switch the loads "on" or "off". This value (the closest available) can then be set according to the description in the programming section.

Technical Data

Note: The two voltage levels before/after the slash are valid for 12 V and 24 V systems respectively.

Technical Data	CIS-05	CIS-10	CIS-20
System voltage	12/24 V auto recognition		
Max. charge current	5 A**	10 A**	20 A**
Max. load current	5 A**	10 A**	20 A**
Float charge	13.8/27.6 V(25 °C)		
Main charge	14.4 V (25 °C), 0.5 h (daily)		
Boost charge	14.4/28.8 V (25 °C), 2 h activation: battery voltage < 12.3/24.6 V		
Equalization	14.8/29.6 V (25 °C), 2 h activation: battery voltage < 12.1/24.2 V (at least every 30 days)		
Deep discharge protection Cut-off voltage	11.00-12.02/22.00-24.04 V By SOC 11.0-11.9/22.0-23.8 V By voltage (adjustable step 0.1/0.2 V)		

Reconnect level	12.8/25.6 V
Overtoltage protection	15.5/31.0 V
Undervoltage protection	10.5/21.0 V
Maximum solar voltage	30 V/50V (12/24 V system voltage)
Temperature compensation (Charge voltage)	-4.2 mV/K per cell
Max. self consumption	Lower than 8/10mA
Grounding	Positive Grounding
Ambient temperature range	-40 to +60 °C**
Maximum operational ambient temperature	50°C
Max. height	4,000 m above sea level
Battery type	lead acid (GEL, AGM, flooded)
Adjustment range: Evening hours Morning hours Night detection	0 – 15 h 0 – 14 h 2.5 – 10.0 V / 5.0 – 20.0 V (adjust step 0.5/1.0 V)

Day detection	4.0 – 11.5 V / 8.0 – 23.0 V (adjust step 0.5/1.0 V)
Wire length	10 cm
Dimensions(WXHXD)	82 x 58 x 20 mm
Weight	150 g
Wire cross section	AWG 13 (2.5 mm ²)
Type of protection	IP68 (1.5 m, 72 h)

Dimming output	CIS-05	CIS-10	CIS-20
Dimming value	0 – 100 % output power (adjust step 10 %)		
Dimming output voltage	0 V to 10 V relative to battery minus		

** : At an ambient temperature above 50°C, with all currents applied, the charge controller will automatically reduce the charge current to limit the internal temperature.

Liability Exclusion

EN

The manufacturer shall not be liable for damages, especially on the battery, caused by use other than as intended or as mentioned in this manual or if the recommendations of the battery manufacturer are neglected. The manufacturer shall not be liable if there has been service or repair carried out by any unauthorized person, unusual use, wrong installation, or bad system design.

Subject to change without notice. Version: 20130412

Made in one of the following countries:

Germany - China - Bolivia - India

Phocos AG - Germany

www.phocos.com

ISO9001



Por favor lea las instrucciones bien y con cuidado antes de usar el producto. Éste viene acompañado de un número de propiedades excelentes, tales como:

- Protección de la caja: protección IP 68, 72 horas en una profundidad de agua de 1,5 m.
- Carga doble.
- Unidad de control (CU) para configurar el controlador de carga CIS mediante conexión de datos por infrarrojo.
- Sensor de temperatura externo para la compensación de tensión de carga Ampliamente programable.
- 3 etapas de carga (por incremento, por compensación, flotante) para batería inundada, 2 etapas de carga (por incremento, flotante) para batería plomada.
- Reconocimiento automático de la tensión del sistema 12/24 V.

Conexión y puesta a tierra



- Conecte los cables en el orden indicado 1234567 para evitar fallos de conexión.
- Para evitar cualquier tensión en los cables, conecte primero el cable al controlador, luego a la batería, al panel o a la carga.
- Tamaño mínimo de cable recomendado: CIS05: 1,5 mm², CIS10: 2,5 mm², CIS20: 4 mm².
- Asegúrese de que el largo del cable entre la batería y el controlador sea lo más corto posible.
- Sepa que los polos positivos de CIS están conectados juntos y que por lo tanto tienen el mismo potencial eléctrico. Si es necesaria una toma a tierra, colóquela siempre de los cables positivos.

- Algunos equipos, como relés, compuertas o motores, pueden dañar el controlador por inducción magnética, cuando se desconecta. Para prevenir esto, conectar inversamente el diodo (como 1N5401 ... 1N5408) entre la CARGA + y la CARGA -.

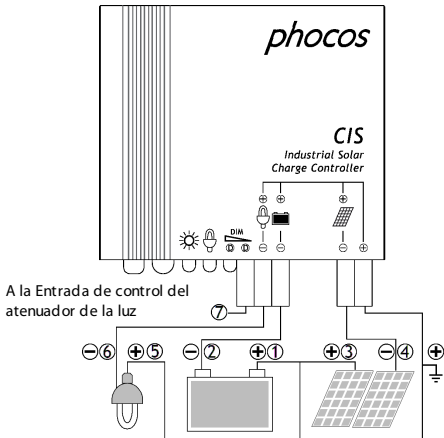
	Función	Marcado del cable	Tamaño del cable (sección)	Color
①	Terminal positivo de la batería	COMMON +	AWG 13 (2.5 mm ²)	rojo
②	Terminal negativo de la batería	BATTERY -	AWG 13 (2.5 mm ²)	negro
③	Terminal positivo del módulo	COMMON +	AWG 13 (2.5 mm ²)	rojo
④	Terminal negativo del módulo	SOLAR -	AWG 13 (2.5 mm ²)	azul
⑤	Terminal positivo de carga	COMMON +	AWG 13 (2.5 mm ²)	rojo
⑥	Terminal negativo de carga	LOAD -	AWG 13 (2.5 mm ²)	verde
⑦	Terminal de señal de atenuación	---	AWG 19 (0.6 mm ²)	negro



Pantalla & Funciones de alerta

LED	Estado	Función
	encendido	Controlador conectado a la batería, noche detectada
	flash	Controlador conectado a la batería, día detectado
	apagado	No hay batería conectada
	encendido	Baja carga/desconexión por alta tensión (LVD/HVD)
	flash	Carga bajo sobrecorriente
	apagado	Carga ok
	encendido	Atenuado debido a la LVD/HVD
	apagado	Atenuado por tiempo controlado
Todas las LED	verde-> rojo->verde->	Programando

Función de lamparilla de noche

Este regulador CIS presenta una función sofisticada de lamparilla de noche, regula la salida de carga en la noche y es ampliamente programable, las salidas son programables de forma independiente.

Se dispone de 3 modos:

controlador estándar y los modos del anochecer al amanecer y tarde/mañana.

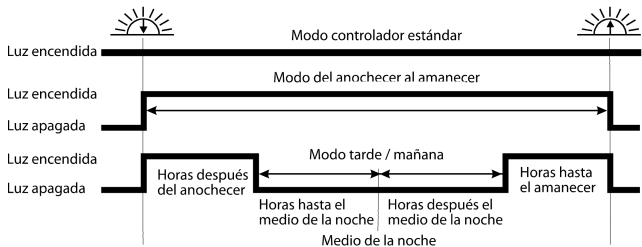

ES

El "medio de la noche" está detectado de forma automática como el punto medio entre el anochecer y el amanecer, no es necesario poner un reloj. Demorará varios días hasta que el controlador haya "aprendido" el medio de la noche con precisión.

El "medio de la noche" puede no concordar con las 12:00 de la medianoche en dependencia de su posición.

El controlador reconoce el día y la noche basado en el panel solar de la tensión en circuito abierto. Este umbral de día/noche puede ser modificado según las condiciones locales de luz y el panel solar utilizado.

Función de prueba

Apretando el botón de prueba en la CU (unidad de control) se encienden ambas terminales de carga por 2 minutos.

Si al apretar el botón se desconecta la carga (baja tensión (LVD)/estado de la carga (SOC), sobreintensidad de corriente) se apagará la carga.

Características de seguridad

	Terminal solar	Terminal de batería	Terminal de carga
Polaridad inversa	protegido (1)	protegido (1)	protegido (2)
Cortocircuito	protegido	protegido (3)	apagado inmediato
Sobrecorriente	no disponible	no disponible	apagado con retardo
Corriente inversa	protegido	no disponible	no disponible
Sobretensión	Máx. 55 V (4)	Máx. 40 V	apagado sobre 15.5 V / 31.0 V
Hipotensión	no disponible	no disponible	apagado
Alta temperatura	Reduce la corriente de carga por PWM en caso de alta temperatura y se apaga la carga si la temperatura alcanza un nivel alto.		

(1) El controlador no puede protegerse a sí mismo en un sistema de 24 V; panel U-batería U está limitado hasta 40 V.

- (2) El controlador puede protegerse a sí mismo, pero las cargas pueden ser dañadas.
- (3) La batería tiene que ser protegida mediante fusible, de lo contrario puede dañarse de forma irreparable.
- (4) La tensión del panel solar no debe sobrepasar este límite por mucho tiempo como protección contra la tensión se utiliza un varistor.

ATENCIÓN: La combinación de diferentes condiciones de error puede causar daños al controlador. ¡Elimine siempre el error antes de continuar con la conexión del controlador!

Función de desconexión en baja tensión (directiva de baja tensión LVD)

- Estado de la carga (SOC) controlado: Se desconecta en 11.00 V/22.00 V hasta 11.70 V/23.40 V(SOC1), 11.12 V/22.24 V hasta 11.76 V/23.52 V(SOC2), 11.25 V/22.50 V hasta 11.83 V/23.63 V(SOC3), 11.38 V/22.72 V hasta 11.89 V/23.78 V(SOC4), 11.51 V/23.02 V hasta 11.96 V/23.92 V(SOC5), 11.64 V/23.28 V hasta 12.02 V/24.04 V(SOC6).
- Tensión controlada (LVD): Se desconecta entre una tensión fija entre 11.0 V/22.0 V y 11.9 V/23.8 V (Salto 0.1 V).

Nota: Los dos niveles de tensión antes / después de la barra son válidos para los sistemas de 12 V y 24 V respectivamente.

Ajustes de fábrica

Usted puede configurar los controladores de carga CIS mediante la unidad de control (CU). Véase el manual de CU para más detalles.

ES

	Ajustes de fábrica
Modo de carga	Controlador estándar
Desconectado por baja tensión	SOC4
Tipo de batería	plomada
Valor de atenuado	50 %

Exclusión de responsabilidad

El fabricante no se responsabilizará de los daños, especialmente de la batería, causados por otro uso que no sea el especificado o mencionado en este manual o si no se cumple con las recomendaciones del fabricante de la batería. El fabricante no se responsabilizará si ha habido un servicio o reparación realizada por una persona no autorizada, del empleo inusual, de una instalación incorrecta o del mal diseño del sistema.

Datos técnicos

Tensión nominal	12/24 V, reconocimiento automático
Tensión por incremento	14.4/28.8 V (25 °C), 2 h
Tensión por compensación	14.8/29.6 V (25 °C), 2 h
Tensión flotante	13.8/27.6 V (25 °C)
Tensión de desconexión de carga	11.00-12.02 V/22.0-24.04 V en caso de SOC 11.00-12.00 V/22.0-24.00 V en caso de tensión
Tensión de reconexión de carga	12.8/25.6 V
Horas de la tarde/horas de la mañana	0-15 horas / 0-14 horas
Valor de atenuado	0...100 % de potencia de salida
Tensión de salida de atenuado	0 V a 10 V relativo al menos de la batería
Detectado de noche/día	2.5-10 V
Tipo de batería	inundada, plomada
Compensación de temperatura	-4.2 mV/K por célula
Corriente solar máxima	5/10/20, de acuerdo con el número de modelo en 60 °C
Corriente de carga máxima	5/10/20, de acuerdo con el número de modelo en 60 °C
Dimensiones	82 x 58 x 20 mm
Tamaño de cable	AWG 13 (2,5 mm ²)

Cósumo de energía típico	Menos de 8/10 mA
Límite de temperatura ambiente	-40 a +60 °C
Protección de la caja	IP68 (1.5 m, 72 h)
Altura máxima/peso	4000 m/150 g

** :A 60 °C CIS sólo puede tener corriente máxima por panel o carga, no juntos

Sujeto a cambios sin previo aviso. Versión: 20130412

Hecho en uno de los siguientes países:

Alemania - China - Bolivia - La India

Phocos AG - Alemania www.phocos.com

ISO9001

 RoHS

Veillez lire attentivement et en profondeur les instructions avant d'utiliser cet appareil. Ce dernier est équipé de remarquables fonctionnalités parmi lesquelles :

- Protection du boîtier : protection indice IP68, résistant à 1,5 m de profondeur dans l'eau pendant 72 heures.
- Double charge.
- Unité de commande servant à configurer le régulateur de charge CIS via un échange de données infrarouge.
- Détecteur de température externe pour compenser les températures des tensions de charge.
- Intégralement programmable.
- 3 modes de recharge (ultra-rapide, équilibrage, conservation) pour les batteries "ouvertes" (plomb-acide), 2 modes de recharge (ultra-rapide, conservation) pour les batteries sans entretien.
- Reconnaissance automatique de la tension de l'appareil 12/24 V.

Raccordement et mise à la terre



- Réalisez les raccords électriques en respectant l'ordre indiqué 1234567, pour éviter tout problème à l'installation.
- Pour éviter toute tension au niveau des fils, commencez par relier en premier lieu le fil au régulateur, puis à la batterie, au panneau ou à la charge.
- Taille minimum de fil recommandée : CIS05 : 1,5 mm², CIS10: 2,5 mm², CIS20 : 4 mm².
- Assurez-vous que la longueur de fil entre la batterie et le régulateur soit aussi courte que possible.

- Gardez à l'esprit que les pôles positifs du régulateur CIS doivent être reliés ensemble et avoir, par conséquent, le même potentiel électrique. Si vous avez besoin de raccorder l'appareil à la terre, effectuez un raccordement sur les fils positifs.
- Certains équipements tels que des relais, des entrées de commande ou des moteurs peuvent endommager le régulateur de charge par induction magnétique lorsqu'il se déconnecte. Afin d'éviter ceci, raccordez la diode (telle que 1N5401... 1N5408) en tension inverse entre LOAD+ (charge+) et LOAD- (charge-).

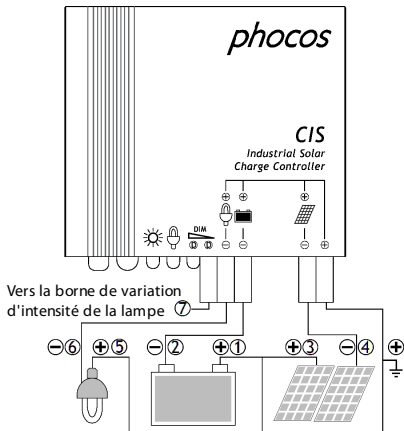
	Fonction	Marquage du câble	Taille du câble (section transversale)	Couleur
①	Borne positive de la batterie	COMMON +	AWG 13 (2.5 mm ²)	rouge
②	Borne négative de la batterie	BATTERY -	AWG 13 (2.5 mm ²)	noir
③	Borne positive du panneau solaire	COMMON +	AWG 13 (2.5 mm ²)	rouge
④	Borne négative du panneau solaire	SOLAR -	AWG 13 (2.5 mm ²)	bleu
⑤	Borne positive de la charge	COMMON +	AWG 13 (2.5 mm ²)	rouge
⑥	Borne négative de la charge	LOAD -	AWG 13 (2.5 mm ²)	vert
⑦	Borne du signal de gradation	---	AWG 19 (0.6 mm ²)	noir



Symboles d'affichage et fonctions d'avertissement

DEL	État	Fonction
	Marche	Régulateur relié à la batterie, détection de nuit
	Clignote	Régulateur relié à la batterie, détection de jour
	Arrêt	Pas de batterie raccordée
	Marche	Déconnexion charge haute/basse tension (LVD/HVD)
	Clignote	Surintensité de la charge
	Arrêt	Charge OK
	Marche	Gradation suite LVD/HVD
	Arrêt	Gradation en fonction de la durée
Toutes les DEL	Vert..>Rouge..>Vert..>	Programmation en cours

Fonction jour/nuit

Ce régulateur CIS est équipé d'une fonction avancée jour/nuit qui commande la charge pendant la nuit et est intégralement programmable. Les deux sorties de charge sont programmables individuellement. Il existe 3 modes différents : standard, crépuscule et soirée/matin.

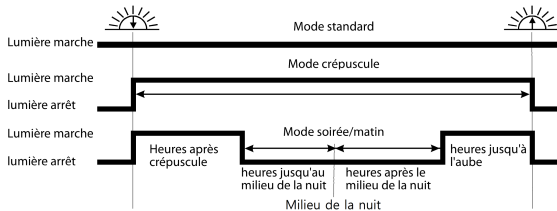

Le "milieu de la nuit" est automatiquement identifié comme point central entre le crépuscule et l'aube, aucune configuration n'est requise. Plusieurs jours peuvent être nécessaires avant que le régulateur "apprenne" à reconnaître le milieu de la nuit avec précision.

Le "milieu de la nuit" peut, en fonction de votre lieu d'habitation, être différent de 00:00.

Le régulateur reconnaît le jour de la nuit grâce à la tension à vide du générateur solaire. Le seuil jour/nuit peut être modifié selon vos conditions d'ensoleillement locales et le générateur solaire utilisé.

Fonction test

En appuyant sur la touche "test" de l'unité de commande, vous mettez sous tension les deux bornes de charge pendant 2 minutes. Si en appuyant sur la touche vous déclenchez un déléstage (LVD/SOC, surintensité), la charge est mise hors tension.

FR

Caractéristiques de sécurité

	Borne solaire	Borne batterie	Borne charge
Polarité inversée	Protégée (1)	Protégée (1)	Protégée (2)
Court-circuit	Protégée	Protégée (3)	S'éteint immédiatement
Surintensité	-	-	S'éteint avec retard
Courant inverse	Protégée	-	-
Surtension	55 V max. (4)	40 V max.	S'éteint au-delà de 15,5 V / 31,0 V
Sous tension	-	-	S'éteint
Surtempérature	Réduit le courant de charge à MIL en cas de surtempérature et coupe la charge si la température atteint un niveau trop élevé		

(1) Le régulateur ne peut pas se protéger dans un système de 24 V ; la tension de la batterie du module est limitée à 40 V.

(2) Le régulateur peut assurer sa propre protection, mais il est possible que le récepteur soit endommagé.

(3) La batterie doit être protégée par un fusible, sinon elle risque de ne plus fonctionner par la suite.

(4) La tension du panneau solaire ne doit pas dépasser la limite autorisée pendant une durée trop longue, car c'est une varistance qui assure sa protection contre les surtensions.

AVERTISSEMENT : Le régulateur peut se détériorer si différents cas de dysfonctionnement surviennent simultanément. Réglez toujours le problème en cours avant de continuer à utiliser le régulateur!

Fonction de protection contre les décharges profondes (LVD)

- Commande de l'état de charge (SOC) : Déconnecté à 11,00 V/22,00 V jusqu'à 11,70 V/23,40 V(SOC1), 11,12 V/22,24 V jusqu'à 11,76 V/23,52 V(SOC2), 11,25 V/22,50 V jusqu'à 11,83 V/23,63 V(SOC3), 11,38 V/22,72 V jusqu'à 11,89 V/23,78 V(SOC4), 11,51 V/23,02 V jusqu'à 11,96 V/23,92 V(SOC5), 11,64 V/23,28 V jusqu'à 12,02 V/24,04 V(SOC6).
- Déclenchement de la tension (LVD) : Déconnecté à une tension fixe comprise entre 11,0 V / 22,0 V et 11,9 V / 23,9 V(par palier de 0,1 V).

Remarque : les deux niveaux de tensions se trouvant avant et après le "/" sont respectivement valables pour des appareils de 12 V et 24 V.

Paramètres d'usine (par défaut)

Vous pouvez configurer le régulateur CIS via l'unité de commande. Consultez le manuel de l'unité de commande pour plus de détails.

FR

	Paramètres d'usine (par défaut)
Mode de charge	Standard
Déconnexion basse tension	SOC4
Type de batterie	Sans entretien
Rapport de gradation	50 %

Clause de non-responsabilité

Le fabricant ne pourra être tenu responsable des dommages, plus particulièrement concernant la batterie, résultant d'une utilisation autre que celle pour laquelle l'appareil est prévu, telle qu'elle est décrite ou mentionnée dans ce mode d'emploi, ou si les recommandations du fabricant de la batterie ne sont pas respectées. Le fabricant ne pourra être tenu responsable en cas de maintenance ou de réparation réalisée par toute personne non habilitée, d'utilisation inappropriée, d'installation incorrecte ou d'une mauvaise conception du système.

Caractéristiques techniques

Tension nominale	12/24 V, reconnaissance automatique
Tension de suralimentation	14,4/28,8 V (25°C), 2 h
Tension d'équilibrage	14,8/29,6 V (25°C), 2 h
Tension de conservation	13,8/27,6 V (25°C)
Tension à la déconnexion de la charge	11,00-12,02 V / 22,00-24,04 V (SOC) 11,0-12,0 V / 22,0-24,0 V (tension)
Tension à la reconnexion de la charge	12,8/25,6 V
Heures de soirée/matinée	0-15 heures/0-14 heures
Valeur de régulation de l'intensité lumineuse	0...100 % puissance de sortie
Tension de sortie lors de la baisse de l'intensité lumineuse	Entre 0 V et 10 V au pôle négatif de la batterie)
Détection nuit/jour	2,5-10 V
Type de batterie	«ouverte» (plomb acide), sans entretien
Compensation de la température	- 4,2 mV/K par cellule
Courant solaire max.	5/10/20, selon la référence du modèle @ 60°C
Courant de charge max.	5/10/20, selon la référence du modèle @ 60°C
Dimensions	82 x 58 x 20 mm
Taille de fil	AWG 13 (2,5 mm ²)

Consommation de courant typique	Inférieure à 8/10 mA
Plage de températures ambiantes**	Entre - 40°C et + 60 °C
Protection du boîtier	IP68 (1,5 m, 72 h)
Altitude max/poids	4.000 m / 150 g

FR

** : À 60°C, le régulateur CIS peut soit traiter le courant max. du panneau solaire, soit le courant max. de la charge, mais pas les deux simultanément.

Susceptible d'être modifié sans préavis. Version : 20130412

Fabriqué dans l'un des pays suivants :

Allemagne - Chine - Bolivie - Inde

Phocos AG – Allemagne

www.phocos.com

ISO9001

 RoHS

Prezado cliente, muito obrigado por adquirir este produto Phocos. Por favor, leia atentamente as instruções completas antes de usar este produto. Ele vem com uma vasta gama de recursos excepcionais, tais como:

- Proteção da caixa: Proteção IP68, 72 horas em águas de 1.5 m de profundidade.
- Carga dupla.
- Unidade de controle (UC) para configurar o controle de carga CIS através de um canal de dados infravermelho.
- Sensor de temperatura externa para a compensação de temperatura da tensão de carga.
- Amplamente programável.
- Carga com 3 estágios (intensificador, de equalização, oscilante) para bateria úmidas, carga com 2 estágios (intensificador, oscilante) para bateria selada.
- Sistema automático de reconhecimento do sistema de tensão 12/24 V.

PO

Conexão e aterramento



- Conecte os fios na ordem indicada 1234567 para evitar falhas na instalação.
- Para evitar a presença de tensão nos fios conecte primeiramente o fio ao controlador, em seguida à bateria, ao painel ou à carga.
- Tamanho mínimo recomendado para a fiação: CIS05: 1,5 mm², CIS10: 2,5 mm², CIS20: 4 mm².
- Assegure-se que o comprimento dos fios entre a bateria e o controlador seja o menor possível.
- Esteja ciente que os terminais positivos do CIS estão conectados juntos e, portanto, têm o mesmo potencial elétrico. Caso um aterramento seja necessário, faça-o sempre nos fios positivos.
- Alguns equipamentos/consumidores como relés e motores poderão danificar o controlador

devido à indução magnética quando são desconectados. Para prevenir esta situação conecte um diodo de maneira reversa (tipo IN5401... IN5408) entre LOAD+ (carga+) e LOAD- (carga-).

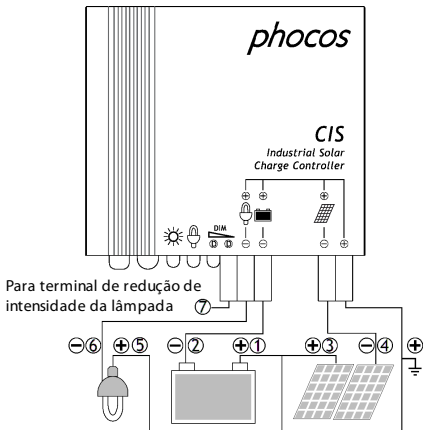
	Função	Maucação tubo retrátil	Diametro/seção	Cor
①	Terminal positivo da bateria	COMMON +	AWG 13 (2.5 mm ²)	vermelho
②	Terminal negativo da bateria	BATTERY -	AWG 13 (2.5 mm ²)	preto
③	Terminal positivo do painel	COMMON +	AWG 13 (2.5 mm ²)	vermelho
④	Terminal negativo do painel	SOLAR -	AWG 13 (2.5 mm ²)	azul
⑤	Terminal positivo da carga	COMMON +	AWG 13 (2.5 mm ²)	vermelho
⑥	Terminal negativo da carga	LOAD -	AWG 13 (2.5 mm ²)	verde
⑦	Terminal com sinal para "Dimmer"	---	AWG 19 (0.6 mm ²)	preto



Funções de Visualização & Advertência

LED	Estado	Função
	Ligado	Controlador conectado à bateria, noite detectada
	Luz intermitente	Controlador conectado à bateria, dia detectado
	Desligado	Nenhuma bateria conectada
	Ligado	Proteção contra baixa/alta tensão (LVD/HVD)
	Luz intermitente	Sobrecorrente de carga
	Desligado	Carga ok
	Ligado	Redução da intensidade de luz devido à LVD/HDV
	Desligado	Redução da intensidade de luz controlado pelo tempo
Todos os LED	Verde ..Vermelho..Verde..	Programação

Função iluminação noturna

Este controle CIS vem acompanhado por uma sofisticada função de iluminação noturna. Ela controla a saída de carga à noite e é amplamente programável. Saídas de carga dupla são programáveis de forma independente.

Existem três modos disponíveis: Modo controlador padrão, crepúsculo ao amanhecer e os modos noturno/matinal.

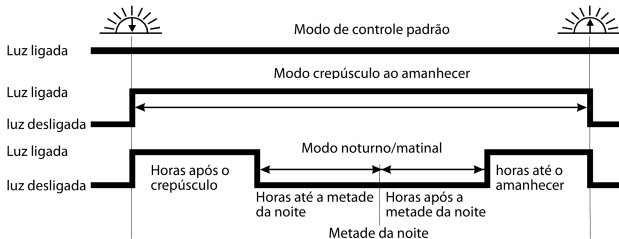

PO

A "metade da noite" é detectada automaticamente como o ponto central entre o crepúsculo e o amanhecer sem que seja necessário ajustar um relógio. Até que o controlador tenha "estabelecido" a metade da noite de maneira precisa pode levar vários dias.

Dependendo da sua localização, a "metade da noite" pode ser diferente de meia-noite.

O controlador reconhece o dia e a noite baseado na tensão de circuito aberto do arranjo solar.

Este limiar dia/noite pode ser modificado de acordo com as condições locais da iluminação e com o arranjo solar utilizado.

Função de testes

Ao pressionar uma tecla de testes na Unidade de Controle (UC), os dois terminais de carga serão ligados por 2 minutos.

Se ao premir a tecla ocorrer um evento de desconexão de carga (LVD - diretiva baixa tensão/SOC – estado da carga, sobrecorrente), a carga será desligada.

Recursos de segurança

	Terminal solar	Terminal da bateria	Terminal de carga
Polaridade reversa	Protegida (1)	Protegida (1)	Protegida (2)
Curto-circuito	Protegido	Protegida (3)	Desligamento imediato
Sobrecorrente	Não se aplica	Não se aplica	Desligamento com temporização
Corrente inversa	Protegido	Não se aplica	Não se aplica
Sobretensão	Máx. 55 V (4)	Máx. 40 V	Desligamento acima 15.5 V / 31.0 V
Subtensão	Não se aplica	Não se aplica	Desligamento
Sobret temperatura	Redução da corrente de carga por PWM (modulação da largura do pulso) na existência de sobret temperatura e desligamento da carga se a temperatura atingir um nível elevado.		

(1) Controlador não pode proteger a si mesmo em um sistema de 24 V; $V_{\text{painel}} - V_{\text{bateria}}$ é limitado a 40 V.

(2) Controlador pode proteger-se, mas os consumidores podem ser danificados.

(3) Bateria deve ser protegida por fusível, ou a bateria será danificada permanentemente.

(4) A tensão do painel solar não deveria exceder este limite por um longo período de tempo porque a proteção de tensão é feita por um varistor.

ADVERTÊNCIA: A combinação de condições de erros diferentes pode causar danos ao controlador. Sempre elimine o erro antes de prosseguir com a conexão do controlador!

Função de proteção contra baixa tensão (LVD)

- Estado de carga (SOC) controlado: Desligar em
11.00 V/22.00 V até 11.70 V/23.40 V(SOC1), 11.12 V/22.24 V até 11.76 V/23.52 V(SOC2),
11.25 V/22.50 V até 11.83 V/23.63 V(SOC3), 11.38 V/22.72 V até 11.89 V/23.78 V(SOC4),
11.51 V/23.02 V até 11.96 V/23.92 V(SOC5), 11.64 V/23.28 V até 12.02 V/24.04 V(SOC6).
- Tensão controlada (LVD): Desligar a uma tensão fixada entre 11.0 / 22.0 V e 11.9 / 23.8 V
(Passo 0.1V).

Observação: Os dois níveis de tensão antes / depois da barra diagonal são respectivamente válidos para os sistemas de 12 V e 24 V.

Ajustes de fábrica

É possível configurar os controles de carga CIS por meio da Unidade de controle (UC). Vide manual UC para maiores detalhes.

	Ajustes de fábrica
Modo da carga	Controlador padrão
Proteção contra baixa tensão	SOC4
Tipo de bateria	selada
Valor de regulagem da intensidade da luz	50 %

Exclusão de responsabilidade

O fabricante exime-se de responsabilidade por quaisquer danos, especialmente à bateria, que possam ser originados da utilização para quaisquer outros fins que não aqueles especificamente indicados ou mencionados neste manual ou oriundos da inobservância das recomendações do fabricante da bateria. O fabricante fica eximido de responsabilidade se a revisão ou o reparo tiver sido realizado por uma pessoa não autorizada ou se o dano for oriundo do uso impróprio, de instalação incorreta ou de um sistema mal desenhado.

Dados técnicos

Tensão nominal	12/24 V, reconhecimento automático
Tensão de reforço	14.4/28.8 V (25°C), 2 h
Tensão de equalização	14.8/29.6 V (25°C), 2 h
Tensão de oscilação	13.8/27.6 V (25°C)
Tensão de desligamento da carga	11.00-12.02 V/22.00-24.04 V por SOC 11.0-12.0 V/22.0-24.0 V por tensão
Tensão de reconexão de carga	12.8/25.6 V
Horas noturnas/horas matinais	0-15 horas/0-14 horas
Valor de regulagem da intensidade da luz	0...100 % potência de saída
Tensão de saída da redução da intensidade da luz	0 V até 10 V referente ao polo negativo da bateria)
Deteção dia/noite	2.5-10 V
Tipo de bateria	Úmida, selada
Compensação da temperatura	-4.2 mV/K por célula
Máx. corrente solar	5/10/20, de acordo com o número de modelo @ 60 °C
Máx. corrente de carga	5/10/20, de acordo com o número de modelo @ 60 °C
Dimensões	82 x 58 x 20 mm
Tamanho dos fios	AWG 13 (2.5 mm ²)

Consumo de energia típico	Inferior a 8/10 mA
Intervalo de temp. ambiente**	-40 até +60 °C
Proteção da caixa	IP68 (1.5 m, 72 h)
Altitude máxima / peso	4.000 m / 150 g

PO

** :Com 60 °C, o CIS pode ter somente corrente total no Painel ou em Carga, mas não juntos

Sujeito a modificações sem aviso prévio. Versão: 20130412

Fabricado em um dos seguintes países:

Alemanha - China - Bolívia – Índia

Phocos AG – Alemanha

www.phocos.com

ISO9001

CE RoHS

亲爱的用户：非常感谢您选用伏科产品！在使用本产品前，请仔细阅读本手册。新一代的CIS控制器，是一款根据最新技术标准开发的，代表最新工业水平的产品。此产品拥有许多卓越的特征：

- 防护等级：IP68，在 1.5 m 水深承受 72 小时不损坏。
- 输出功率在 0.....100%可调。
- 控制器本身无任何按键，通过遥控器（CU）设置。
- 外置温度补偿传感器，测量环境温度更准确。
- 先进的可编程功能，可灵活定时夜间照明时间。
- 三阶段充电控制（强充，均衡充，浮充）。
- 12/24 V 系统电压自动识别。



接线和接地

- 按照图中数字标出的连线顺序把控制器连接到您的太阳能系统中。
- 为了避免电缆上的电压，请首先连接控制器端，然后是蓄电池、太阳能电池板和负载。
- 推荐线径：CIS05: 1.5 mm²；CIS10: 2.5 mm²；CIS20: 4 mm²。
- 确保蓄电池和控制器之间的电缆长度尽可能短，防止电缆上的压降过高引起的控制器误判。
- 控制器为共正极设计。因此如果系统需要接地，只允许正极接地。
- 继电器、恒流驱动电源、电机等设备关闭时产生的电磁感应可能损坏控制器，为防止此发生，请在控制器负载正负极间反接二极管（例如 1N5401... 1N5408）用以保护。

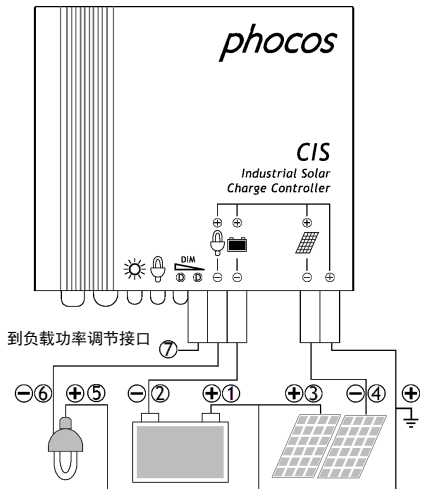
	功能	线缆标识	线径规格	颜色
①	蓄电池正极	COMMON +	AWG 13 (2.5 mm ²)	红色
②	蓄电池负极	BATTERY -	AWG 13 (2.5 mm ²)	黑色
③	电池板正极	COMMON +	AWG 13 (2.5 mm ²)	红色
④	电池板负极	SOLAR -	AWG 13 (2.5 mm ²)	蓝色
⑤	负载正极	COMMON +	AWG 13 (2.5 mm ²)	红色
⑥	负载负极	LOAD -	AWG 13 (2.5 mm ²)	绿色
⑦	调功信号输出	---	AWG 19 (0.6 mm ²)	黑色



显示和报警功能

LED 灯	状态	功能
	点亮	蓄电池连接到控制器上，时间为夜晚
	闪烁	蓄电池连接到控制器上，时间为白天
	关闭	没有连接蓄电池
	点亮	负载低压切断或高压保护
	闪烁	负载过流
	关闭	负载正常
	点亮	输出功率调节功能因蓄电池电压达到设定的低压启动电压而启动或者负载高压保护
	关闭	负载按设定功率正常运行
所有 LED 灯	循环点亮	编程中

路灯功能

CIS 控制器具有先进的路灯控制功能。负载点亮时间和方式都可以根据客户需要灵活的编程。有 3 种模式可供选择：
通用控制器、黄昏到清晨和夜晚/清晨两段式模式。

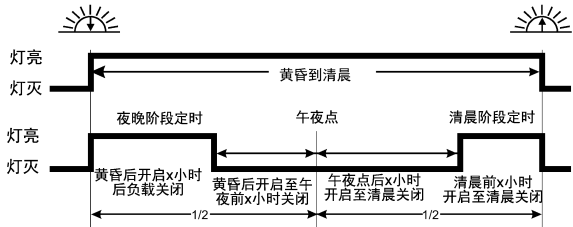

“午夜点”的确定，控制器会根据实际的黄昏与清晨的持续时间，自动识别中间点，也就是控制器认为的午夜点，不需要用户设定真正的时间。控制器自动确认准确的午夜点需要几天时间的运行。这种方式可能在某些时候不是太准确，但是可以避免用户在不同的季节对时钟进行校核。控制器确定的午夜点与实际时间的午夜是不相同的。控制器通过测量太阳能电池的开路电压，识别白天和黑夜。根据所处不同地区和不同太阳能电池板，用户可以自行设置不同的光控点电压（白天和黑夜的临界电压）。

测试功能

在遥控器（CU）上，有一测试按键（Test）。按此按键可将控制器的负载端打开 2 分钟。在白天，CIS 的测试功能可以帮助判断系统安装是否正确，也可以帮助排除故障。如果按编程按钮打开负载后，导致系统进入 LVD（放电保护）状态，负载会自动关闭。当系统处于 LVD 状态时，测试功能不可用。

安全特性

	太阳能端	蓄电池端	负载端
极性反接	保护（1）	保护（1）	保护（2）
短路	保护	保护（3）	立即切断
过流	N/A	N/A	延时切断
反向充电电流	保护	N/A	N/A
过压	最高 55 V	最高 40 V	大于 15.5 V/31 V 切断
欠压	N/A	N/A	切断负载
过温	当温度过高时，控制器会用 PWM 方式限制充电电流；如果温度达到一定的高度，控制器会切断负载。		

- (1)、在 24 V 系统中, 如果蓄电池端或太阳能端有一端极性反接就可能损坏控制器。
 - (2)、控制器可以保护自己, 负载很有可能已经损坏。
 - (3)、我们强烈建议在蓄电池和控制器之间接上保险丝, 否则蓄电池会永久性损坏。
 - (4)、太阳能端是靠变阻器分压实现保护功能的, 因此太阳能端电压不能长时间高于 55 V。
- 警告: 两个或两个以上的不同的错误条件同时存在很有可能损坏控制器, 所以在继续下一步操作前, 首先要先排除现有故障。

低压切断功能(LVD)

- 蓄电池电量方式(SOC)控制: 断开负载在
11.00/22.00 V 至 11.70/23.40 V(SOC1), 11.12/22.24 V 至 11.76/23.52 V(SOC2),
11.25/22.50 V 至 11.83/23.63 V(SOC3), 11.38/22.72 V 至 11.89/23.78 V (SOC4),
11.51/23.02 V 至 11.96/23.92 V (SOC5), 11.64/23.28 V 至 12.02/24.04 V (SOC6)。
- 蓄电池电压(LVD)控制: 负载保护电压固定, 11.0/22.0 V 至 11.9/23.8 V。(精度 0.1 V)

注释: 斜线前后的数值分别代表在 12 V 和 24 V 系统中的电压值。

出厂设置

CIS 控制器是通过遥控器（CU）进行设置的，详细的设置信息请见 CU 说明书。

	出厂设置
负载控制方式	通用控制器
低压保护方式	SOC4
蓄电池类型	胶体蓄电池
输出功率	50 %额定功率

免责声明

生产商不承担，由于违反本手册建议或提及的规范，以及忽视蓄电池生产商的建议而造成的任何损失。如果有由非指定人员提供维护服务、不正常使用、错误安装或者错误的系统设计情况出现，生产商不承担任何责任。

技术参数

额定电压	12/24 V, 自动识别
强冲电压	14.4/28.8 V (25 °C), 持续 2 小时
均衡充电电压	14.8/29.6 V (25 °C), 持续 2 小时
浮充电压	13.8/27.6 V (25 °C)
低压切断电压	11.00-12.02 V/22.00-24.04 V 电量控制 11.0-12.0 V/22.0-24.0 V 电压控制
负载再连接电压	12.8 / 25.6 V
夜晚/凌晨运行时间	0-15 小时 / 0-14 小时
额定电压	12/24 V, 自动识别
输出功率调节范围	0...100 % 负载功率
功率调节端子输出电压范围	0 --- 10 V (相对于电池负极)
白天/黑夜识别电压范围	2.5-10 V
蓄电池类型	胶体, 液体
温度补偿系数	-4.2 mV/K per cell
最大充电/负载电流	5/10/20 A, 由型号确定 @ 60 °C
尺寸/重量	82x58x20 mm (w x h x d) / 150 g

线径规格	AWG 13 (2.5 mm ²)
自消耗功率	低于 8/10 mA
工作温度范围**	-40 到 + 60 °C
海拔高度/防护等级	4000 m/IP 68 (1.5 m, 72 h)

**：在 60 °C 时，只能在太阳能端或负载端一端满载运行。

CH

如有更改，恕不另行通知。版本：20130412

在以下国家生产：

德国 - 中国 - 玻利维亚 - 印度

Phocos AG - Germany www.phocos.com

ISO9001

 RoHS